

|  |  |  |  |  |  |
|--|--|--|--|--|--|
|  |  |  |  |  |  |
|  |  |  |  |  |  |
|  |  |  |  |  |  |
|  |  |  |  |  |  |
|  |  |  |  |  |  |
|  |  |  |  |  |  |
|  |  |  |  |  |  |
|  |  |  |  |  |  |
|  |  |  |  |  |  |
|  |  |  |  |  |  |
|  |  |  |  |  |  |
|  |  |  |  |  |  |
|  |  |  |  |  |  |
|  |  |  |  |  |  |
|  |  |  |  |  |  |
|  |  |  |  |  |  |
|  |  |  |  |  |  |
|  |  |  |  |  |  |



|  |  |  |  |  |  |  |    |  |
|--|--|--|--|--|--|--|----|--|
|  |  |  |  |  |  |  |    |  |
|  |  |  |  |  |  |  |    |  |
|  |  |  |  |  |  |  |    |  |
|  |  |  |  |  |  |  |    |  |
|  |  |  |  |  |  |  |    |  |
|  |  |  |  |  |  |  |    |  |
|  |  |  |  |  |  |  |    |  |
|  |  |  |  |  |  |  |    |  |
|  |  |  |  |  |  |  |    |  |
|  |  |  |  |  |  |  |    |  |
|  |  |  |  |  |  |  |    |  |
|  |  |  |  |  |  |  |    |  |
|  |  |  |  |  |  |  | °C |  |
|  |  |  |  |  |  |  | °C |  |
|  |  |  |  |  |  |  |    |  |
|  |  |  |  |  |  |  |    |  |
|  |  |  |  |  |  |  |    |  |
|  |  |  |  |  |  |  |    |  |



|  |  | <i>l</i> |  |  | <b>h</b> |
|--|--|----------|--|--|----------|
|  |  |          |  |  |          |
|  |  |          |  |  |          |
|  |  |          |  |  |          |
|  |  |          |  |  |          |









|  |  |  |  |  |  |  |  |
|--|--|--|--|--|--|--|--|
|  |  |  |  |  |  |  |  |
|  |  |  |  |  |  |  |  |
|  |  |  |  |  |  |  |  |
|  |  |  |  |  |  |  |  |
|  |  |  |  |  |  |  |  |

|  |  |  |  |  |  |  |  |
|--|--|--|--|--|--|--|--|
|  |  |  |  |  |  |  |  |
|  |  |  |  |  |  |  |  |

| 3 |  |  |
|---|--|--|
|   |  |  |

| 1 |  |  |
|---|--|--|



|   |  |  |  |  |              |  |  |
|---|--|--|--|--|--------------|--|--|
|   |  |  |  |  | <b>2019</b>  |  |  |
|   |  |  |  |  | <b>(t/a)</b> |  |  |
|   |  |  |  |  |              |  |  |
|   |  |  |  |  |              |  |  |
| 3 |  |  |  |  | 10           |  |  |
| 4 |  |  |  |  | 1            |  |  |
|   |  |  |  |  |              |  |  |

|  |  |  |  |  |  |  |  |
|--|--|--|--|--|--|--|--|
|  |  |  |  |  |  |  |  |
|  |  |  |  |  |  |  |  |
|  |  |  |  |  |  |  |  |
|  |  |  |  |  |  |  |  |
|  |  |  |  |  |  |  |  |
|  |  |  |  |  |  |  |  |
|  |  |  |  |  |  |  |  |

|  |  |  |  |  |  |  |  |
|--|--|--|--|--|--|--|--|
|  |  |  |  |  |  |  |  |
|  |  |  |  |  |  |  |  |
|  |  |  |  |  |  |  |  |
|  |  |  |  |  |  |  |  |
|  |  |  |  |  |  |  |  |
|  |  |  |  |  |  |  |  |
|  |  |  |  |  |  |  |  |

|  |  |  |  |  |  |  |  |
|--|--|--|--|--|--|--|--|
|  |  |  |  |  |  |  |  |
|  |  |  |  |  |  |  |  |
|  |  |  |  |  |  |  |  |
|  |  |  |  |  |  |  |  |
|  |  |  |  |  |  |  |  |
|  |  |  |  |  |  |  |  |
|  |  |  |  |  |  |  |  |

|  |  |  |  |  |  |  |  |
|--|--|--|--|--|--|--|--|
|  |  |  |  |  |  |  |  |
|  |  |  |  |  |  |  |  |
|  |  |  |  |  |  |  |  |
|  |  |  |  |  |  |  |  |
|  |  |  |  |  |  |  |  |
|  |  |  |  |  |  |  |  |
|  |  |  |  |  |  |  |  |

3

| 4    |                      |                       |                       |      |
|------|----------------------|-----------------------|-----------------------|------|
|      | 2010                 |                       |                       |      |
|      | 156973m <sup>2</sup> | 68590.6m <sup>2</sup> | 79441.3m <sup>2</sup> |      |
|      |                      | 31120                 | 2010                  | 8    |
|      |                      | [2010]061             | 2014                  | 4    |
|      | [2014]017            |                       |                       | 2015 |
| 4    |                      |                       | 2015023               |      |
| 2016 |                      |                       |                       |      |

|  |  |  |  |  |  |  |
|--|--|--|--|--|--|--|
|  |  |  |  |  |  |  |
|  |  |  |  |  |  |  |
|  |  |  |  |  |  |  |
|  |  |  |  |  |  |  |

|  |  |  |  |  |  |  |
|--|--|--|--|--|--|--|
|  |  |  |  |  |  |  |
|  |  |  |  |  |  |  |
|  |  |  |  |  |  |  |
|  |  |  |  |  |  |  |
|  |  |  |  |  |  |  |

|  |  |  |  |  |
|--|--|--|--|--|
|  |  |  |  |  |
|  |  |  |  |  |
|  |  |  |  |  |

GB16297-1996 2

GB16297-1996 2

3

GB12348-2008 3 4



| 1-18 |  | dB(A)           |  |
|------|--|-----------------|--|
|      |  |                 |  |
|      |  |                 |  |
|      |  |                 |  |
|      |  |                 |  |
|      |  |                 |  |
|      |  |                 |  |
|      |  |                 |  |
|      |  |                 |  |
|      |  |                 |  |
| 4    |  |                 |  |
|      |  | 1-19            |  |
|      |  | 1-19            |  |
|      |  |                 |  |
|      |  |                 |  |
|      |  |                 |  |
|      |  |                 |  |
|      |  | HW49 900-041-49 |  |
|      |  |                 |  |

°C



1

2

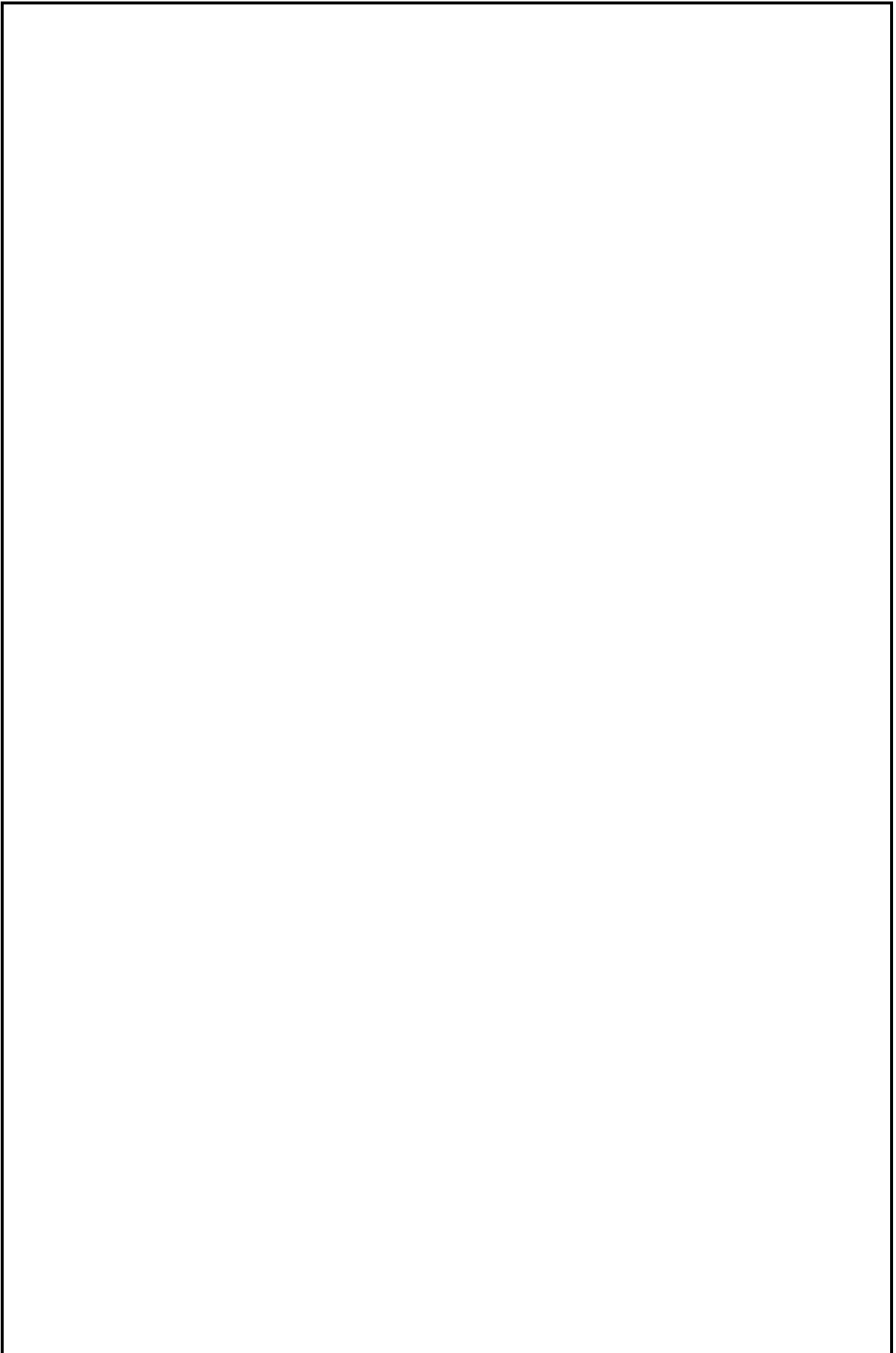

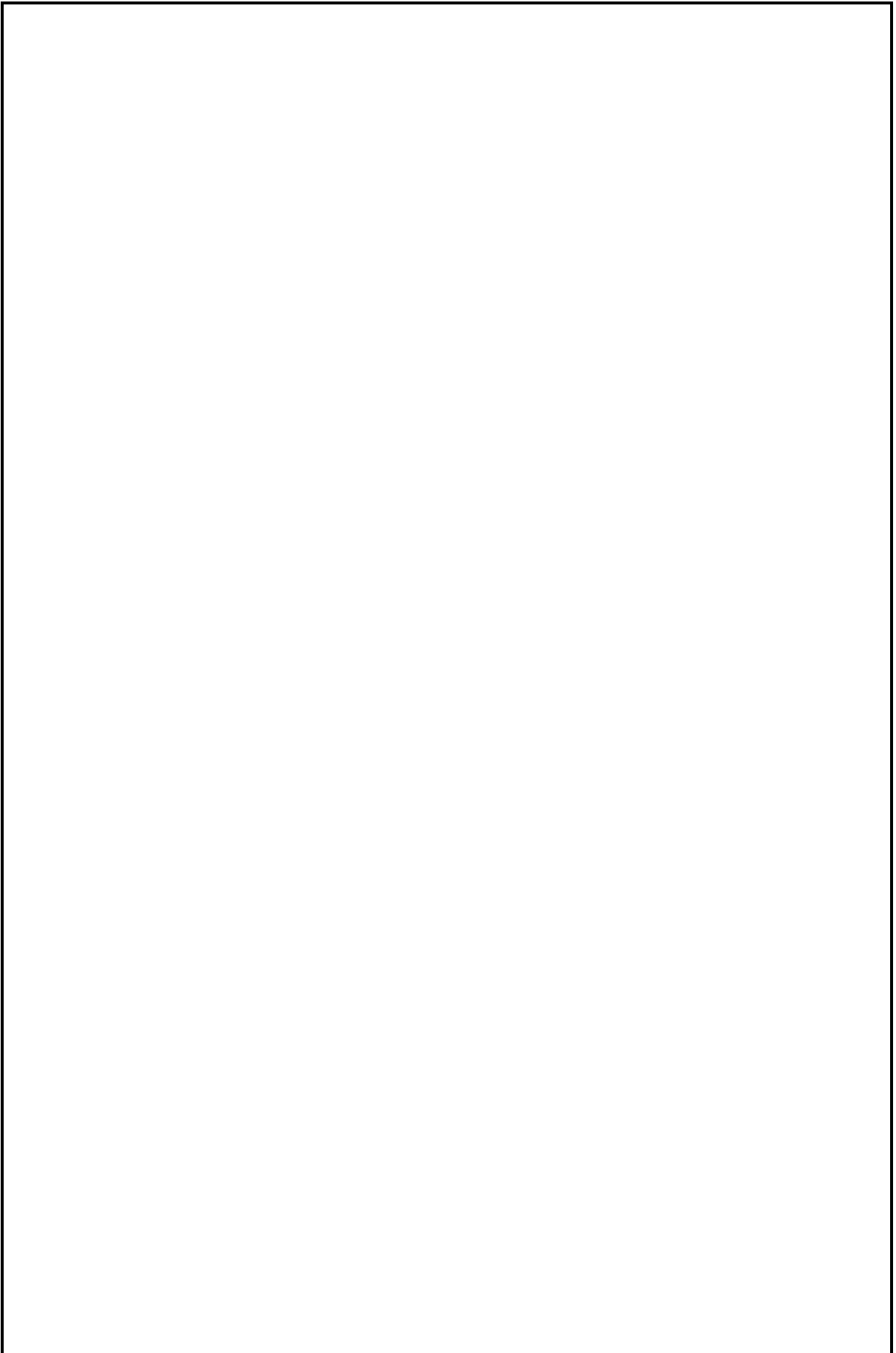

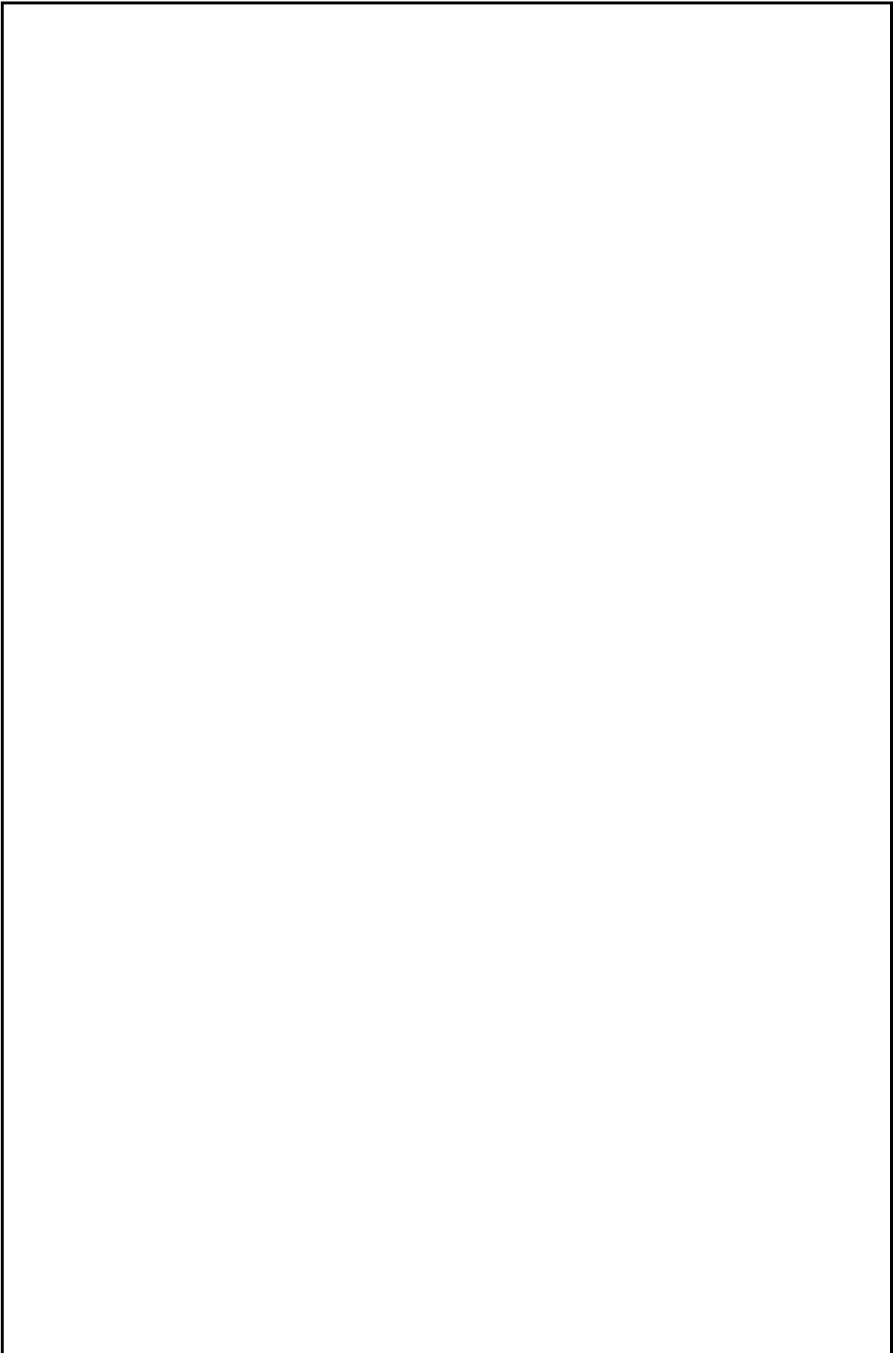







|  |          |          |  |  |  |  |          |
|--|----------|----------|--|--|--|--|----------|
|  | <b>m</b> |          |  |  |  |  |          |
|  | <b>X</b> | <b>Y</b> |  |  |  |  | <b>m</b> |
|  |          |          |  |  |  |  |          |
|  |          |          |  |  |  |  |          |

1.

4-1



2.

II

III

III

4-2

mg/L

|  |  | II |  |
|--|--|----|--|
|  |  |    |  |
|  |  |    |  |
|  |  |    |  |

**4-3**

**dB A**

|  |  |  |  |
|--|--|--|--|
|  |  |  |  |
|  |  |  |  |
|  |  |  |  |

1

|  |  |   |
|--|--|---|
|  |  | A |
|  |  |   |
|  |  |   |
|  |  |   |
|  |  |   |
|  |  |   |
|  |  |   |
|  |  |   |
|  |  |   |

2

|  |                   |  |  |
|--|-------------------|--|--|
|  | mg/m <sup>3</sup> |  |  |
|  |                   |  |  |
|  |                   |  |  |

3

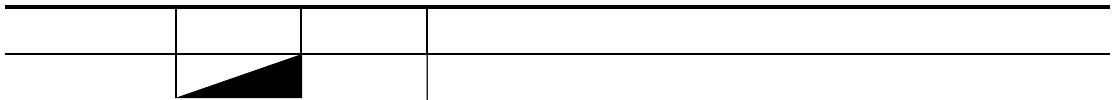



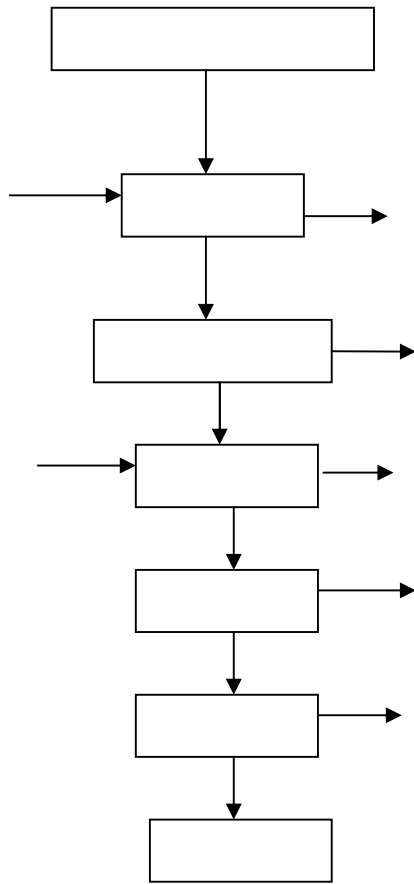



|  |  |    |  |  |
|--|--|----|--|--|
|  |  |    |  |  |
|  |  |    |  |  |
|  |  |    |  |  |
|  |  |    |  |  |
|  |  | S2 |  |  |
|  |  | S3 |  |  |
|  |  |    |  |  |

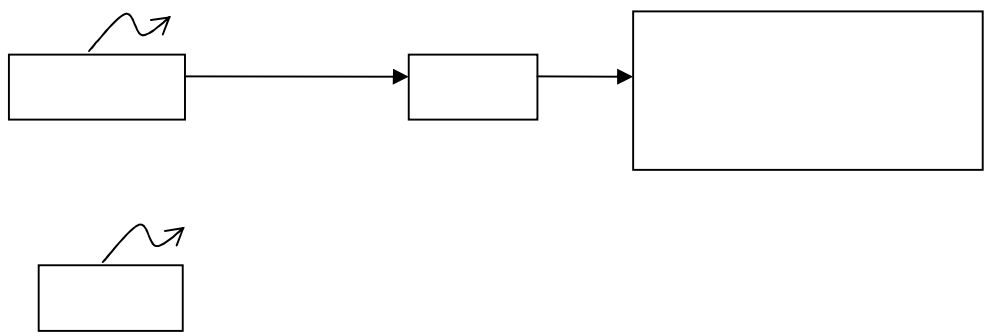

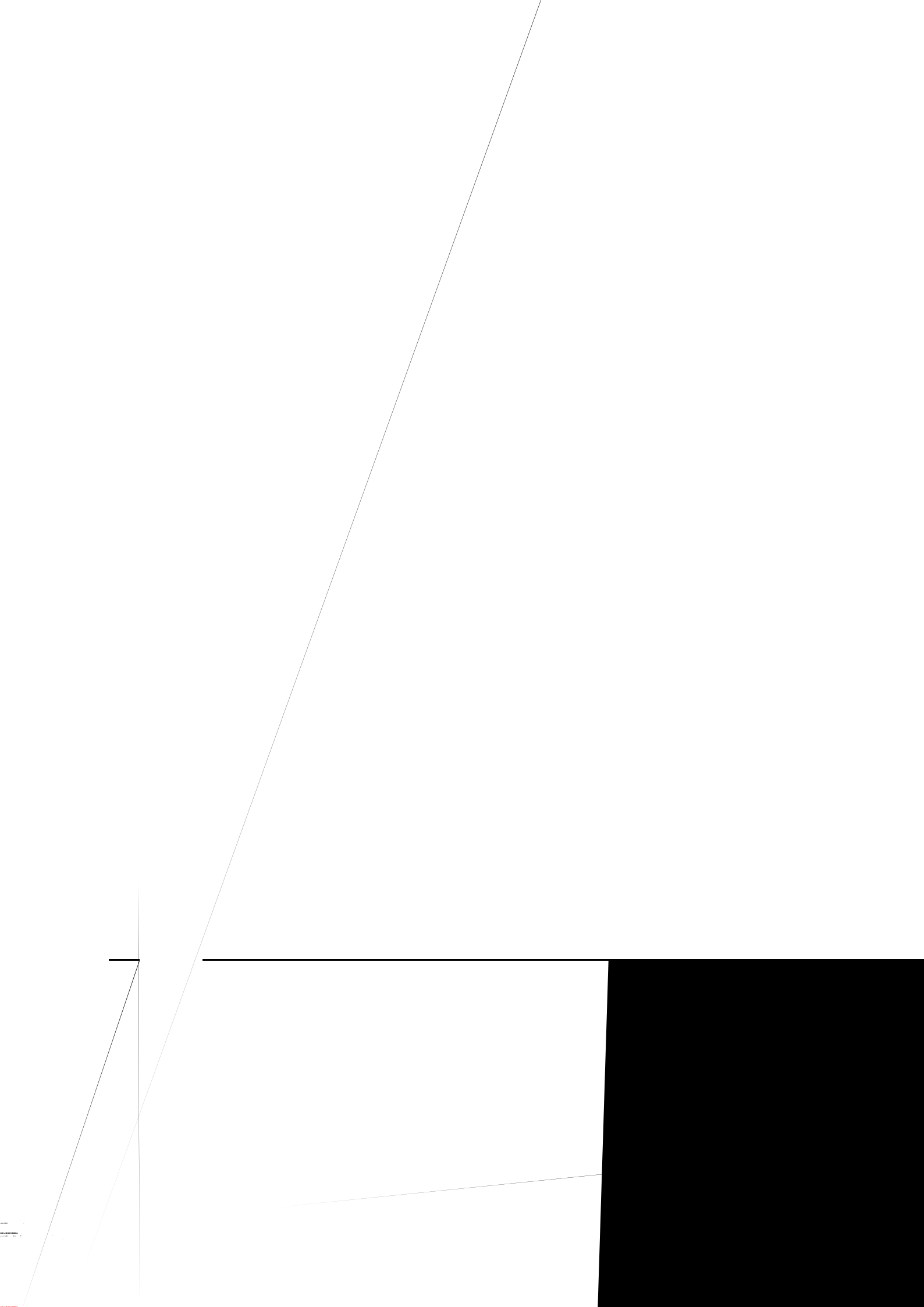



---

|  |  |      |      |  |        |
|--|--|------|------|--|--------|
|  |  |      |      |  |        |
|  |  |      | 0    |  | 0.038  |
|  |  |      |      |  | 0.008  |
|  |  |      | 0    |  | 0.004  |
|  |  |      |      |  | 0.0004 |
|  |  |      | 0    |  | 0.0008 |
|  |  |      |      |  |        |
|  |  |      |      |  |        |
|  |  | 100  | 100  |  | 0      |
|  |  | 1200 | 1200 |  | 0      |

|  |  |      |      |  |   |   |  |  |
|--|--|------|------|--|---|---|--|--|
|  |  |      |      |  |   |   |  |  |
|  |  |      |      |  |   |   |  |  |
|  |  |      |      |  |   |   |  |  |
|  |  |      |      |  |   |   |  |  |
|  |  |      |      |  |   |   |  |  |
|  |  |      |      |  |   |   |  |  |
|  |  |      |      |  |   |   |  |  |
|  |  |      |      |  |   |   |  |  |
|  |  |      |      |  |   |   |  |  |
|  |  |      |      |  |   |   |  |  |
|  |  |      |      |  |   |   |  |  |
|  |  |      |      |  | 0 | 0 |  |  |
|  |  |      |      |  |   | 0 |  |  |
|  |  | 1200 | 1200 |  | 0 | 0 |  |  |
|  |  |      |      |  | 0 | 0 |  |  |
|  |  |      |      |  |   |   |  |  |
|  |  |      |      |  |   |   |  |  |
|  |  | 5    | 95   |  |   |   |  |  |
|  |  |      |      |  |   |   |  |  |
|  |  |      |      |  |   |   |  |  |
|  |  |      |      |  |   |   |  |  |
|  |  |      |      |  |   |   |  |  |













|  |  |  |
|--|--|--|
|  |  |  |
|  |  |  |
|  |  |  |
|  |  |  |
|  |  |  |

$$\frac{Q_c}{C_m} = -\frac{BL^C}{A} + r L^D$$

$\pi$

|  |  |  |  |  |  |  |
|--|--|--|--|--|--|--|
|  |  |  |  |  |  |  |
|  |  |  |  |  |  |  |

7.2.3

①

$$Lr = L - \frac{r}{r} - \Delta L$$

②

$$L = \sum_{i=1}^n L_i$$

|  |  |  |  |  |  |  |  |
|--|--|--|--|--|--|--|--|
|  |  |  |  |  |  |  |  |
|  |  |  |  |  |  |  |  |
|  |  |  |  |  |  |  |  |
|  |  |  |  |  |  |  |  |
|  |  |  |  |  |  |  |  |
|  |  |  |  |  |  |  |  |
|  |  |  |  |  |  |  |  |



|  |  |  |  |  |  |  |  |  |  |
|--|--|--|--|--|--|--|--|--|--|
|  |  |  |  |  |  |  |  |  |  |
|  |  |  |  |  |  |  |  |  |  |
|  |  |  |  |  |  |  |  |  |  |

7.2.5

|  |  |          |          |
|--|--|----------|----------|
|  |  | <b>t</b> | <b>t</b> |
|  |  |          |          |
|  |  |          |          |
|  |  |          |          |
|  |  |          |          |
|  |  |          |          |

|  |  |  |   |
|--|--|--|---|
|  |  |  |   |
|  |  |  |   |
|  |  |  | / |
|  |  |  | / |
|  |  |  | / |

|  |  |              |            |             |  |
|--|--|--------------|------------|-------------|--|
|  |  | <b>q t/a</b> | <b>Q t</b> | <b>qi/Q</b> |  |
|  |  |              |            |             |  |
|  |  |              |            |             |  |



|  |  |  |  |  |  |
|--|--|--|--|--|--|
|  |  |  |  |  |  |
|  |  |  |  |  |  |
|  |  |  |  |  |  |
|  |  |  |  |  |  |

**7.2.5-4**

|  |  |  |  |  |
|--|--|--|--|--|
|  |  |  |  |  |
|  |  |  |  |  |

|  |  |  |  |  |  |
|--|--|--|--|--|--|
|  |  |  |  |  |  |
|  |  |  |  |  |  |
|  |  |  |  |  |  |
|  |  |  |  |  |  |

|  |  |
|--|--|
|  |  |
|  |  |

**7.2.6**

|  |  |
|--|--|
|  |  |
|  |  |
|  |  |
|  |  |

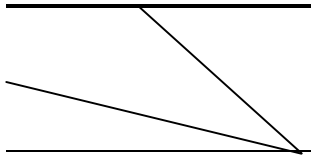
|   |  |  |  |  |  |  |  |  |  |
|---|--|--|--|--|--|--|--|--|--|
|  |  |  |  |  |  |  |  |  |  |
|   |  |  |  |  |  |  |  |  |  |
|   |  |  |  |  |  |  |  |  |  |
|   |  |  |  |  |  |  |  |  |  |
|   |  |  |  |  |  |  |  |  |  |

**7.2.7**

**7.2.8**



|  |  |  |
|--|--|--|
|  |  |  |
|  |  |  |

|  |  |  |  |
|--|--|--|--|
|  |  |  |  |
|  |  |  |  |

7.2.9 “ ”

7.2.9-1 “ ”

|  |  |  |                   |  |     |  |
|--|--|--|-------------------|--|-----|--|
|  |  |  |                   |  | ( ) |  |
|  |  |  |                   |  |     |  |
|  |  |  |                   |  |     |  |
|  |  |  |                   |  |     |  |
|  |  |  |                   |  |     |  |
|  |  |  | 100m <sup>2</sup> |  | 50  |  |
|  |  |  |                   |  |     |  |
|  |  |  |                   |  |     |  |
|  |  |  |                   |  |     |  |
|  |  |  |                   |  |     |  |
|  |  |  |                   |  |     |  |

|  |  |  |  |
|--|--|--|--|
|  |  |  |  |
|  |  |  |  |
|  |  |  |  |
|  |  |  |  |

|  |  |  |                   |  |
|--|--|--|-------------------|--|
|  |  |  |                   |  |
|  |  |  |                   |  |
|  |  |  |                   |  |
|  |  |  |                   |  |
|  |  |  |                   |  |
|  |  |  | 100m <sup>2</sup> |  |
|  |  |  |                   |  |
|  |  |  |                   |  |
|  |  |  |                   |  |

